



V16 is the latest Magnimage high performance full 4K video switcher. The hardware architecture is based on large capacity high-speed FPGA and high-speed digital matrix, and internally adopts RGB 24bit/60Hz processing. With the advanced scaling engine built-in, it supports seamless switching among multi-screens with an excellent image quality and realistic color and no latency. Adopt hybrid matrix input, clients have a variety of 4K/2K input module customization options, support 4Kx2K/60Hz 4:4:4 input/output. It also supports real-time monitoring for the input and output.

Cooperate with MIG-H9 console, it can realize fade switch among multi-layers or multi-scenes, widely applied in the auto show, commercial meeting, product launches and stage performances.

### **Product Feature**

- ✓ 16 x 4K program output, 2 x 4K AUX output
- ✓ 1 x Multi-window preview, preview interface support customize, 1 x HDMI console monitor
- ✓ Support 10G OPT output
- ✓ Max. 24 input ports of 4K x 2K/60Hz 4:4:4
- ✓ Mixed use for 4K/2K cards, Meet a variety of input requirements
- ✓ Supports to 32 layers for one screen, up to 48 layers for whole machine
- ✓ Support 8 background(pixel to pixel)
- ✓ Support HDCP1.4&2.2
- ✓ Input EDID management
- ✓ Image crop, Layer zoom
- ✓ Support layer feathering function
- ✓ Support chroma key and luma key
- ✓ Support edge blending
- ✓ Support external synchronization, Multi-machine cascade
- ✓ Dual redundant power supply

## Switcher Introduction

### Menu Display

Show V16 current operation status, able to check input information/electric status/ firmware version, etc.

### Power Switch



### Menu Keys

Including knob, OK, return button for menu selection and operation

### Input ports

### Program output, 16 x 4K output

### Dual power backup

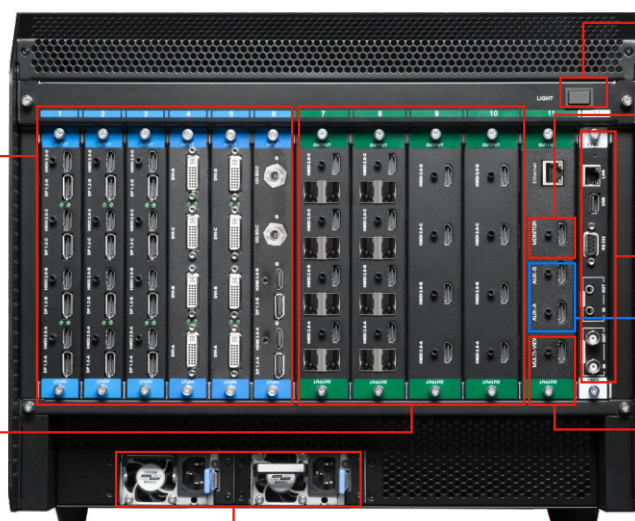

### Light Switch

### Monitoring for console

### Control board

### AUX output

### Multi-window preview output

## Software Control

V16 video switcher can controlled by software, easy and quick operation.



LAN Cable



# ▮ Various Input and Output Ports

## 📦 Input Ports

Max. 6 input card slots, user can select input card freely.

2K input card including 4 x HDMI; 4K input card including 4 x DP/HDMI, 2 x DP/HDMI + 2 x SDI mixed.

Single port 4K\*2K/60Hz

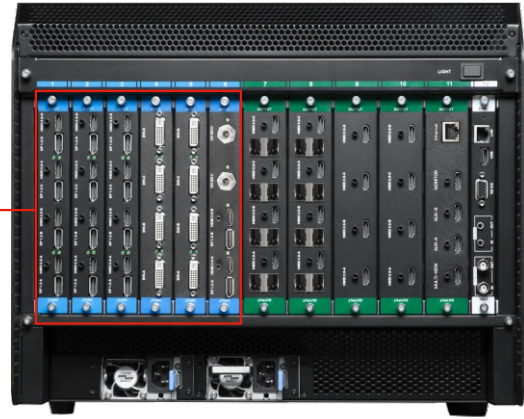
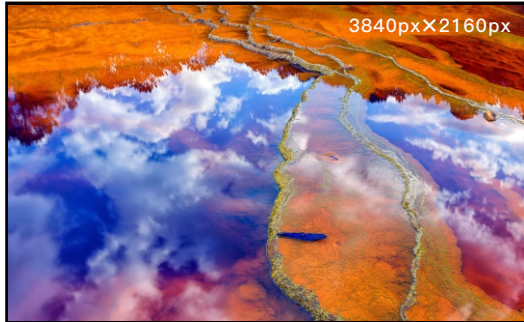

## 📦 Output Ports

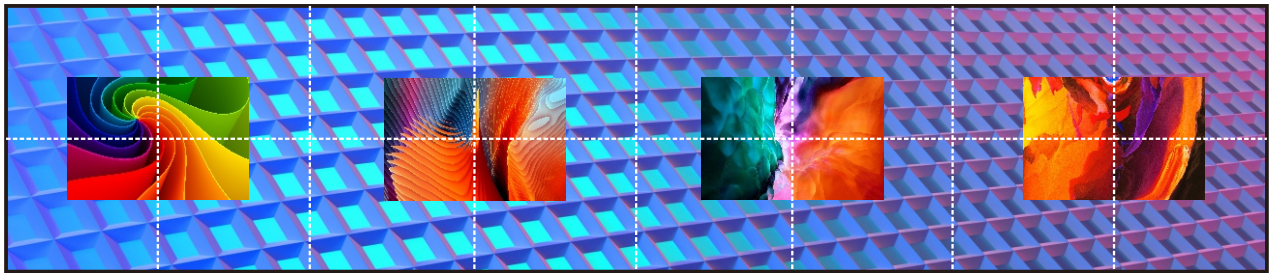

16 program output: can customize output resolution and mosaic layout(8 x 2 or 2 groups of 4x2), Max. 32 layers for program output.

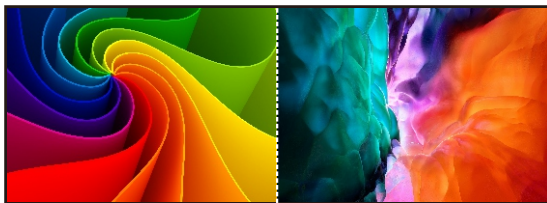

2 AUX output: can select input source independently to corresponding output, support quick switch.



1 HDMI monitoring port for console



1 Multi-window preview output

System Connection Diagram

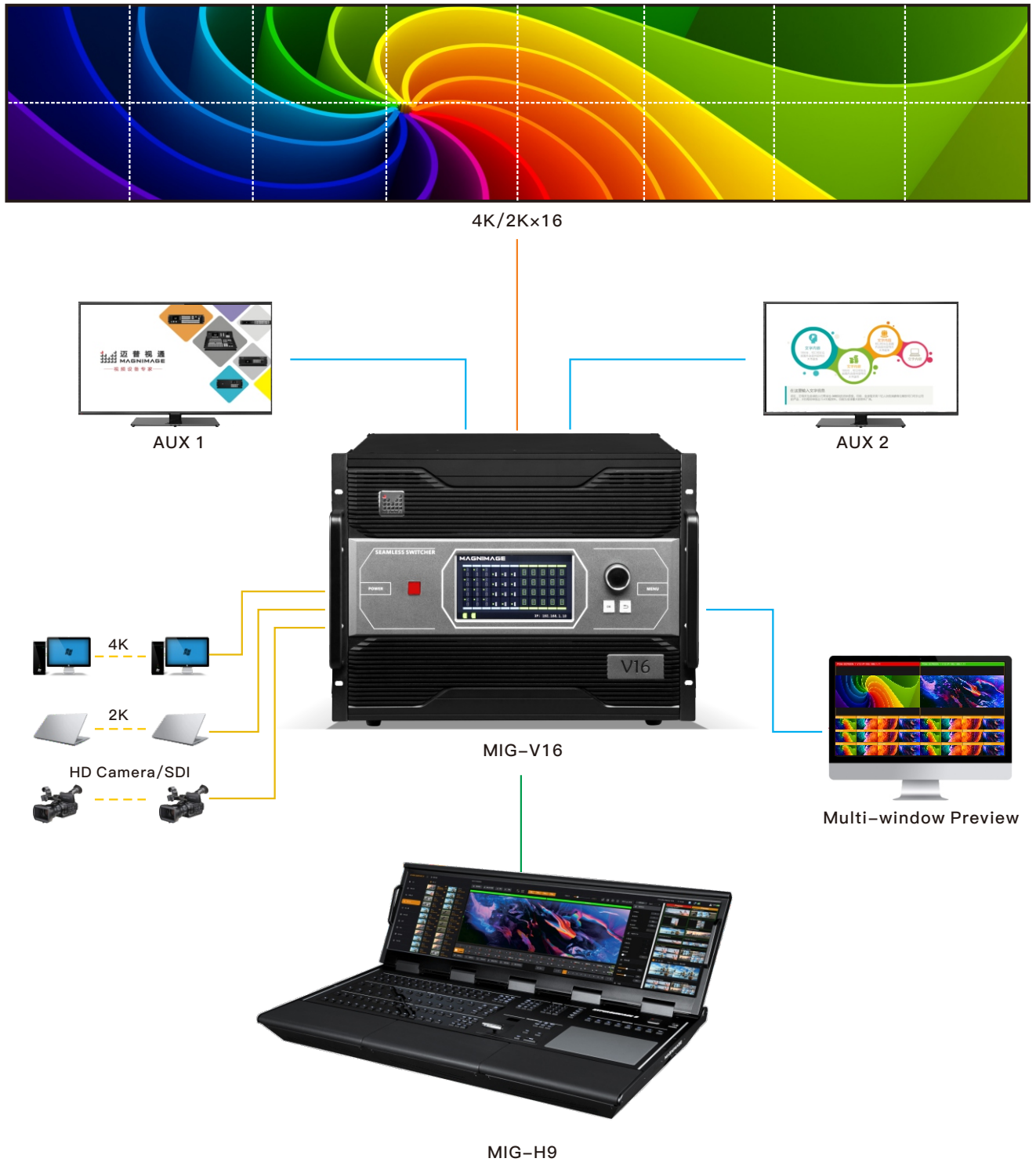

System Connection Diagram

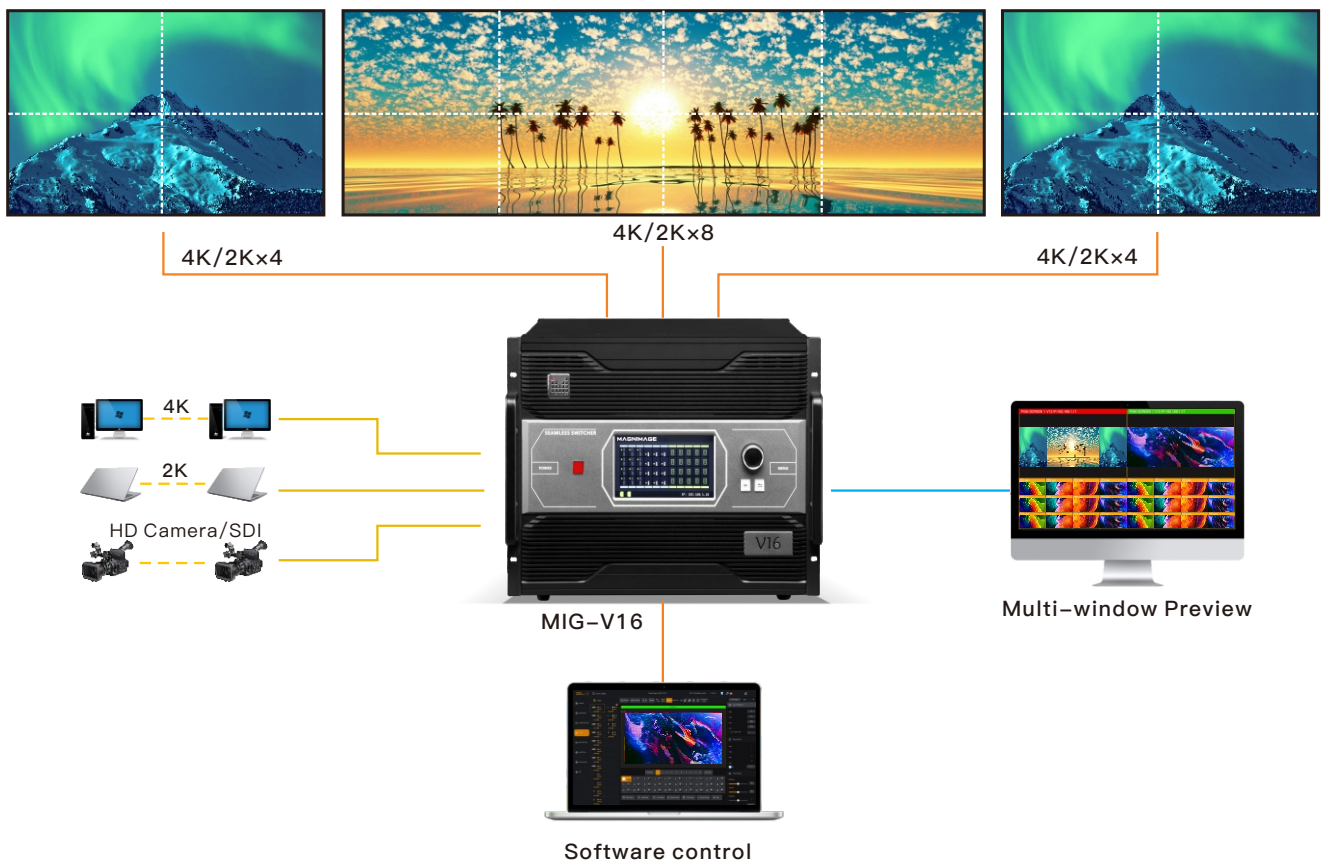
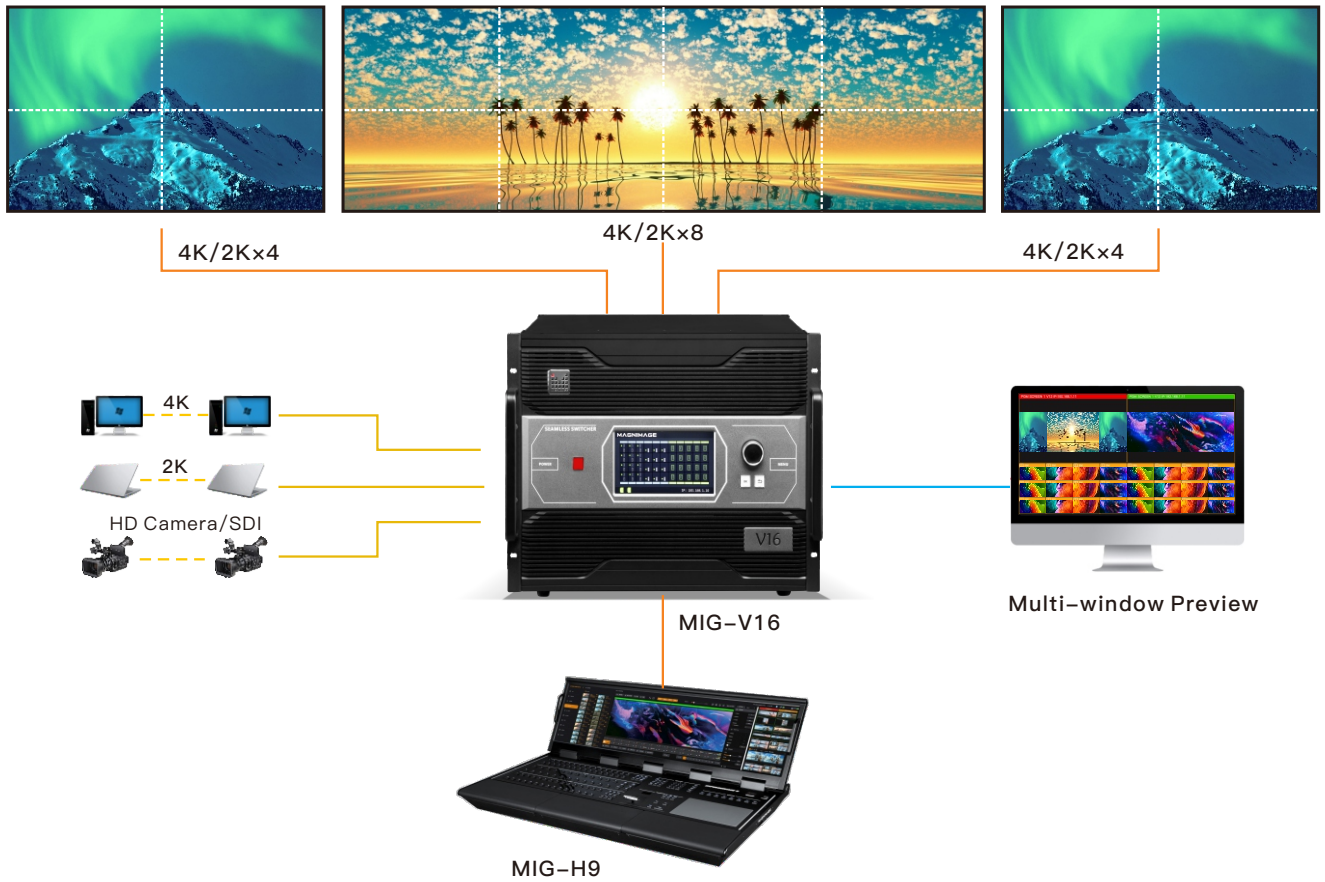

## V16 projection blending mosaic

Program outputs support projection edge blending which can adjust blending size, position, direction and gamma for each output port. One V16 can support blending for max. 16 sets 4K projections.

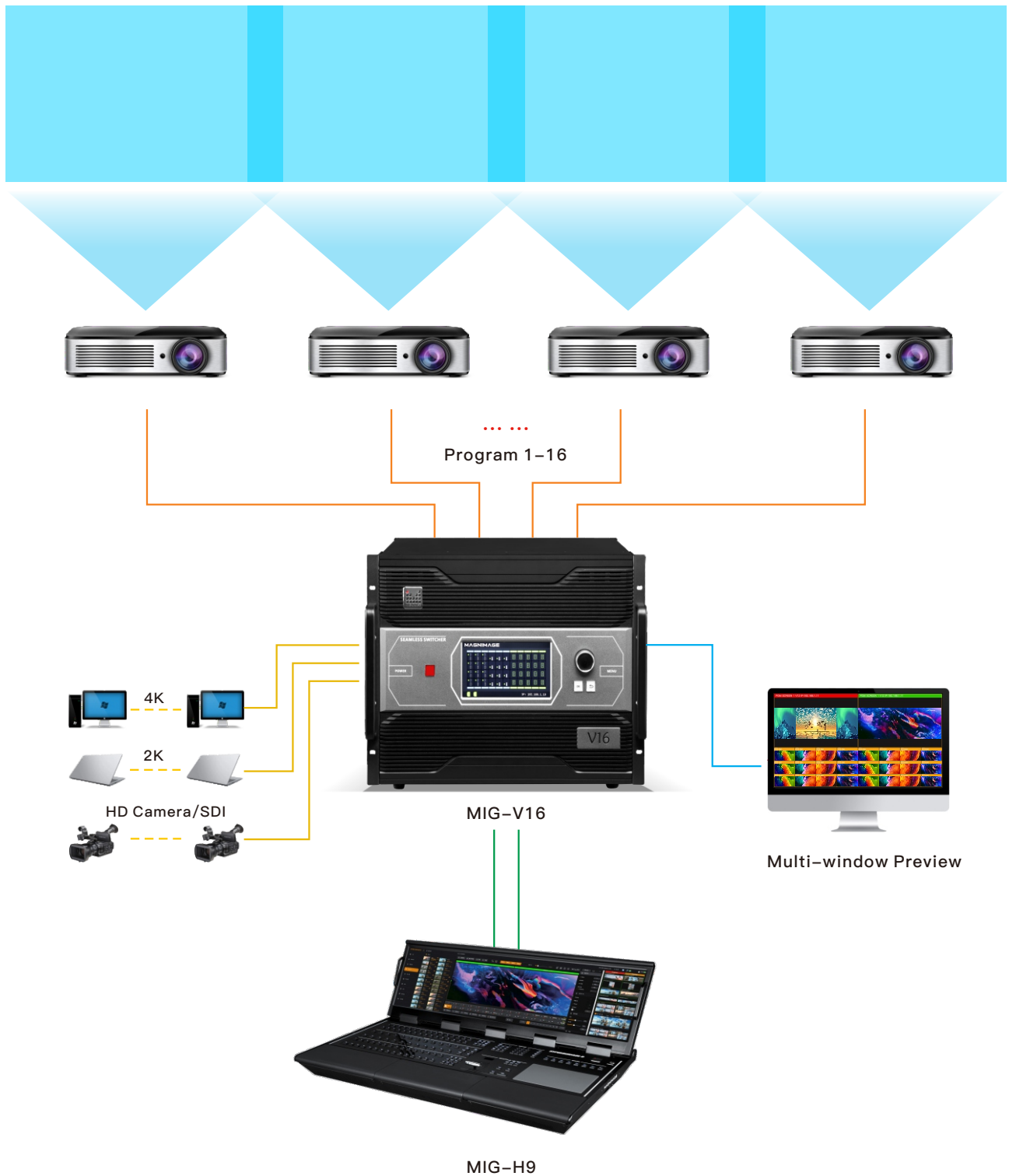

## Technical Parameters

Input Information			
Input Card Model	Ports	Quantity	Resolution
4DP+4HDMI	DP1.2 /HDMI2.0	4+4	3840×2160/60Hz、7680×1080/60Hz and customized
2DP+2HDMI+2SDI	DP1.2/HDMI2.0 +12G SDI	2+2+2	3840×2160/60Hz、7680×1080/60Hz and customized/4K SDI backward compatibility
4DVI	DVI-D	4	VESA 1920X1080/60Hz and customized
4SDI	12G SDI	4	4K SDI backward compatibility

Output Information				
Board Type	Interface Type	Port	Quantity	Resolution Specification
Main Output Board	HDMI	HDMI2.0	4	VESA 3840x2160/60Hz、3840x2160/50Hz and customized Normal output board: maximum resolution of width is 4096, maximum resolution of height is 2176 Feathering output board: maximum resolution of width is 7680, maximum resolution of height is 3500
	HDMI+OPT	HDMI2.0+10G Fiber Optic	4+8	
Aux Output Board	AUX Output	HDMI 2.0	2	VESA 3840×2160/60Hz、3840×2160/50Hz and customized; maximum resolution of width is 4096, maximum resolution of height is 2176
	Echo Output	HDMI1.3	1	1920X 1080/60Hz
	Multi-preview	HDMI1.3	1	1920X 1080/60Hz

Unit Specification	
Power Supply	100-240V AC
Consumption	50/60Hz
Operating Temperature	0~45℃
Power supply frequency	600W
Net Weight	32.6KG

## Production Dimension

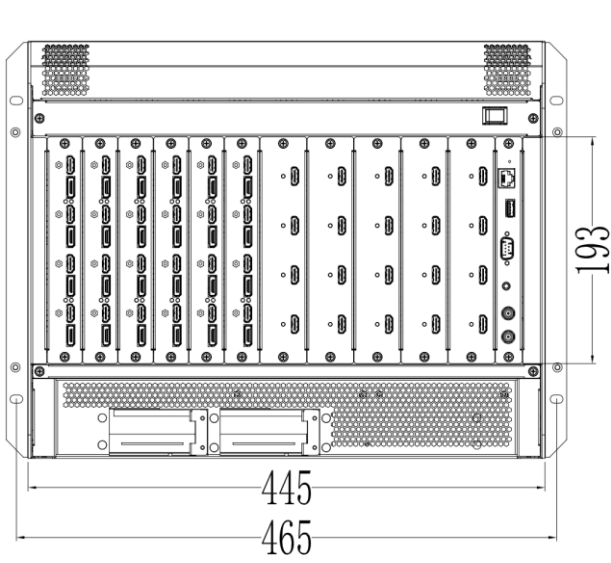

Front View

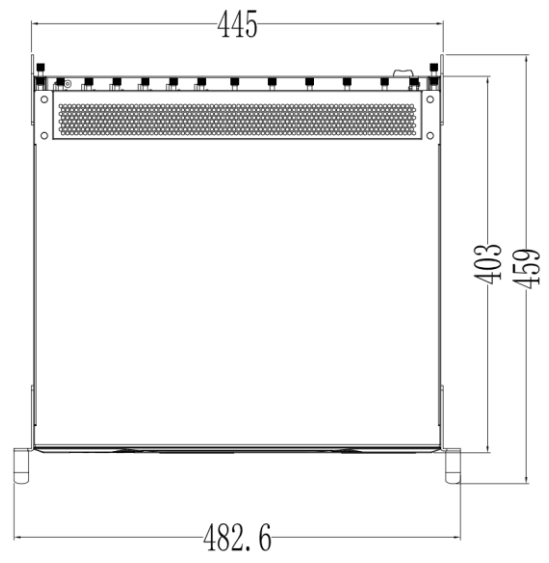

Bottom View

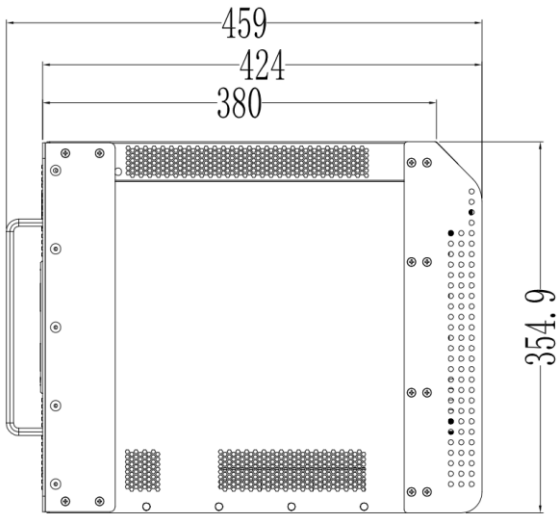

Left View

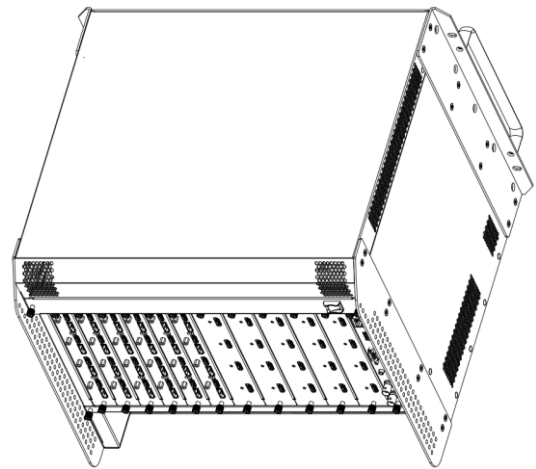

Ratio: 0.7

Left View



**Shenzhen Magnimage Technology Co., Ltd.**

Address: 801, Bld. G2, TCL International E City, #1001  
 Zhongshan Park Road, Nanshan, Shenzhen, China, 518052  
 Tel: 86-755-8664 7651 Fax: 86-755-8664 7650  
 Website: [www.magnimage.com](http://www.magnimage.com)